



# International Journal for Innovative Engineering and Management Research

A Peer Reviewed Open Access International Journal

www.ijiemr.org

## COPY RIGHT



ELSEVIER  
SSRN

**2018 IJIEMR.** Personal use of this material is permitted. Permission from IJIEMR must be obtained for all other uses, in any current or future media, including reprinting/republishing this material for advertising or promotional purposes, creating new collective works, for resale or redistribution to servers or lists, or reuse of any copyrighted component of this work in other works. No Reprint should be done to this paper, all copy right is authenticated to Paper Authors

IJIEMR Transactions, online available on 27<sup>h</sup> Nov 2018. Link

[:http://www.ijiemr.org/downloads.php?vol=Volume-07&issue=ISSUE-12](http://www.ijiemr.org/downloads.php?vol=Volume-07&issue=ISSUE-12)

Title: **SIMULATION OF BUS CLAMPING PWM FOR GRID CONNECTED THREE LEVEL NEUTRAL POINT CLAMPED INVERTERS**

Volume 07, Issue 12, Pages: 357–362.

Paper Authors

**E. SONA SHYLAJA, P.SADANANDAM**

vaagdevi college of engineering



USE THIS BARCODE TO ACCESS YOUR ONLINE PAPER

To Secure Your Paper As Per **UGC Guidelines** We Are Providing A Electronic Bar Code

## **SIMULATION OF BUS CLAMPING PWM FOR GRID CONNECTED THREE LEVEL NEUTRAL POINT CLAMPED INVERTERS**

**<sup>1</sup>E. SONA SHYLAJA, <sup>2</sup>P.SADANANDAM**

<sup>1</sup>Dept electrical and electronics engineering, vaagdevi college of engineering

<sup>2</sup>Associate professor, Dept electrical and electronics engineering, vaagdevi college of engineering

### **Abstract**

Renewable energy is spreading in various format of supplying electricity such as in domestic purposes, grid integration, power generation and hybrid vehicle. Grid integration is one of the aspect is a necessary concern. This paper elaborates the control strategy installation necessary for grid integration. Most of the time, conventional inverters are used but in this paper the new multilevel inverter control strategy is taken for various purposes including cost, simple construction and less losses. This paper introduces a three level NPC inverter which uses space vector modulation for pulse generation. Three level NPC inverter contributes many benefits such as power quality improvement, reduction in harmonics, lower cost and improved efficiency. This document involves a novel control strategy with voltage oriented control using PR controller which helps the system to cope up the difficulties of the grid transmitting energy.

**Keywords:** Three Level NPC inverter; PR controller; Space Vector Modulation; Power quality improvement; Grid integration.

### **1. Introduction**

Technology now-a-days is changing as it is seen in few decades. Now the industries are reliable on long lasting clean energy sources. The most complicated phenomenon to be considered when using an economic, clean energy source is the efficiency and cost of the inverter [1]. As the conventional inverters have lot of problems compared to the upgraded inverters, so it is preferable to use multilevel inverters. In that case, the multi level inverters development is necessary. The policy that every industry believes is to make the technology compact and to increase the efficiency which will result in reduction of cost. To do so it is necessary to develop

multilevel inverters. Now the industries are reliable on long lasting clean energy sources. The most complicated phenomenon to be considered when using an economic, clean energy source is the efficiency and cost of the inverter [1]. As the conventional inverters have lot of problems compared to the upgraded inverters, so it is preferable to use multilevel inverters. In that case, the multi level inverters development is necessary. The policy that every industry believes is to make the technology compact and to increase the efficiency which will result in reduction of cost. To do so it is necessary to develop multilevel inverters. Considering the fact that

the multilevel inverters are more reliable than the conventional inverters, it is required to use insulated gate bipolar transistors (IGBTs) which are used for the purpose of switching. The probable development of IGBTs makes a difference in implementing the multilevel inverters [2, 4]. In recent years, the multilevel inverters gave the benefits of changing the voltage level and power ratings drastically. This makes the system compact which leads to the advantages of implementing such a topology. The advantages of such inverters cover the ride through capability problems, a substantial design development, dynamic performance improvement, large operating range of voltages and reduction in harmonics [1, 4]. The multilevel inverters have three different topologies dictated as neutral point clamped H-bridge and flying capacitors inverters [1]. Among these inverters, the NPC inverters have gain the attention and became the mostly implemented inverter for the clean energy sources. This paper briefs about the implementation three level NPC inverters that are to be implemented on different control strategies. In this paper, the NPC inverter with respect to the space vector modulation technique is implemented.

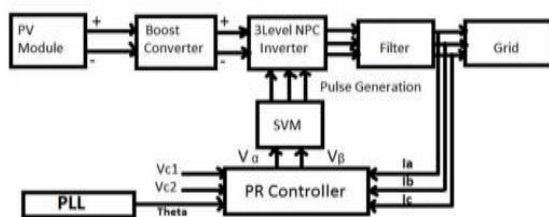

Fig 1. Proposed Model

This paper is focusing on increasing the efficiency as well as reduction in harmonics [4]. Most attention is paid towards

implementing the SVM technique on three level NPC inverters.

### 1.1. Three Level NPC Inverter

The three level NPC topology consist of 12 switches including 6 diodes. It is necessary to connect two capacitors in series both charged with  $V_{dc}$  [1]. Each phase leg contains 4 series switches with two diodes clamped in series. The main function of the diodes is to clamp the upper switches at higher potential to the zero dc-link point. A particular switching pattern will give the output of three level NPC inverter [4].

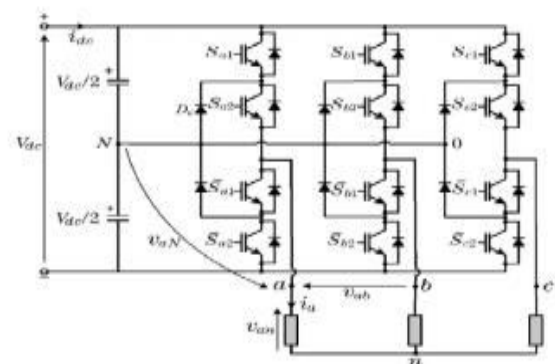

Fig 2. Three level NPC inverter

The circuit diagram shown above in fig 2 gives idea about the arrangement of the power circuit required for the three level NPC inverter. In this circuit, the diodes are arranged in such a way that it yields different stages of voltages with respect to neutral point N. The splitting of the voltage level is considered according capacitors C1 and C2 arranged in series with each other having neutral point N in between them. The division of voltages are obtained as  $V_{dc}/2$ , 0,  $-V_{dc}/2$ . So it is named as three level topology [1]. In this topology, the switches  $S_{a1}$  and  $S_{a2}$  are turned ON giving  $V_{dc}/2$ . For  $-V_{dc}/2$ , switches  $S_{a1'}$  and  $S_{a2'}$  are switched ON and for 0,  $S_{a1'}$  and  $S_{a2}$

are necessary to turned ON. This power circuit will then give the three level topology. The difference between the conventional inverter and the three level topology is that diodes used for the purpose of splitting the voltages. The dc bus voltages level gets half as the diode D1 and D1' are used. When switches Sa1 and Sa1' turn ON the voltage across a and 0 is Vdc. In this case, diode D1' balance the voltage sharing between Sa1' and Sa2'. Sa1' helps blocking the voltage across C1 and Sa2' helps blocking the voltage across C2 [1]. It is observed that the voltage across Van is AC while Vao is DC. So while considering a and 0, when the output is removed, the circuit will act like a dc-dc converter.

## 1.2. Space Vector Modulation

The space vector modulation technique is available for all kind of multilevel inverters. SVM technique is featured with the benefits as low current ripple, easy hardware implementation and good dc-link voltage utilization. So this technique is used for various applications of high voltage and high power. The number of switches increases as the level of inverter increases [5]. So this causes complexity in implementing the SVM technique. Table no.1 briefs about the switching states of three level NPC inverter using SVM shown below,

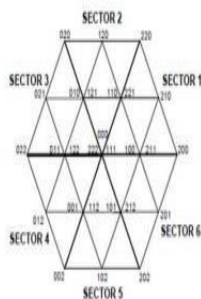

Fig 3. Space vector modulation three level NPC inverter

Table 1. Three Level Switching State

Output Voltage Van	Gate signal		Switching state S <sub>i</sub>
	S <sub>a1</sub>	S <sub>a2</sub>	
Vdc/2	1	1	(+)
0	0	1	0
-Vdc/2	1	0	(-)

The three phase system is balanced when,

$$V_{a0} + V_{b0} + V_{c0} = 0 \quad (1)$$

The instantaneous voltage is given by,

$$V_a = V \sin(\theta t) \quad (2)$$

$$V_b = V \sin(\theta t + \frac{2\pi}{3}) \quad (3)$$

$$V_c = V \sin(\theta t + \frac{4\pi}{3}) \quad (4)$$

When three phase supply is given to the ac machine it creates a rotating flux. This flux is represented in the form of voltage vector. The magnitude and the angle of these vectors are calculated by means of using Clarke's transformation as,

$$V_{ref} = V_a + jV_\beta = \frac{2}{3} (V_a + aV_b + a^2V_c) \quad (5)$$

Where a is illustrated as,

$$a = e^{j\frac{2\pi}{3}} \quad (6)$$

The magnitude and angle of the reference vector are calculated as,

$$|V_{ref}| = \sqrt{V_a^2 + V_\beta^2} \quad (7)$$

$$\theta = \tan^{-1}(\frac{V_\beta}{V_a}) \quad (8)$$

The voltage vector on the alpha beta axis can be determined as,

$$V_\alpha = \frac{2}{3} (V_a - \frac{1}{2}V_b - \frac{1}{2}V_c) \quad (9)$$

$$V_\beta = \frac{2}{3} (\frac{\sqrt{3}}{2}V_b - \frac{\sqrt{3}}{2}V_c) \quad (10)$$

## 2. Proposed work on Voltage Oriented Control using PR Controller

In a case of every control strategy PI controller is most prominent controller to be used. But there are many disadvantages of PI controller such as high inrush current (transient) cause adverse effect on dynamic response of the converter [1]. The standard procedure to implement voltage oriented control on any controller is to go through the park's and Clarke's transformation. The fact is that PI controller can be easily constructed on voltage oriented control but the implementation needs lot of transformation stages. So the system gets complicated and it increases the complexity of the computation [2].

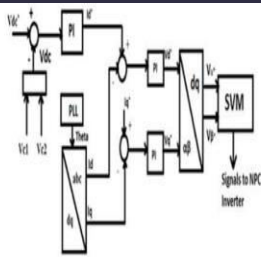

Fig 4. VOC PI controller

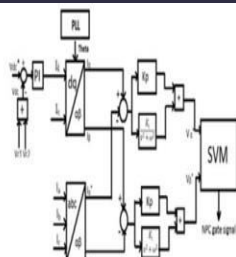

Fig 5. VOC PR controller

Therefore it is necessary to reduce inrush current and the complexity of the circuit. In order to deal with such complication, PR controller has been constructed. The Proportional Resonant controller is as same as the PI controller. PI controller is used to generate the d-axis current while PR controller used d-axis current and makes q-axis current zero to obtain unity power factor [1]. In this method using inverse transformation, the reference currents  $I_d$  and  $I_q$  are converted into stationary reference frame alpha and beta currents observed from three phase output inverter currents. Then, the reference stationary frame voltages are directly given to the constants having the proportional resonant transfer function given as shown in [6],

$$G_{PR} = K_p + \frac{K_i}{s^2 + \omega^2}$$

The steady state error can be minimized by making the resonant frequency equals to the grid frequency. Where  $K_p$  is proportional gain constant,  $K_i$  is the integral gain constant and  $\omega$  is resonant frequency. Infinity gain can be achieved by means of resonant frequency which will minimize the steady state error. Using PR controller with VOC reduces the stages of transformation which minimizes the complexity of computation. The other advantage is good dynamic response with fast reference tracking.

### 3. Results

The proposed work is implemented by using MATLAB software. The parameters are calculated using the formulae. The input is taken from the PV panel of 220V which is boosted from converter at a duty of 47%. This boost converter gives voltage of 415V. By implementing the transfer function of PR controller, the output can be given to the space vector modulation technique.

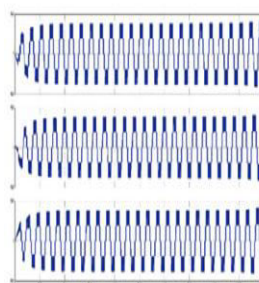

Fig 6. Three Level NPC Inverter output



Fig 7. Grid voltage and Grid current

The SVM technique gives a THD of 6.27% using PR controller. The grid voltage is 400Vrms so the DC-DC link capacitor shares an equal voltage of 210V balances the DC link which when added gives 420V i.e. received from the boost converter. Twenty PV panels are connected in string and array fashion which give the voltage of 210V. Each panel is considered to have 21V, 2.3A rating. The VOC-PR controller compared to VOC-PI controller provides less transformation stages and better performance during transient stability. The inrush current is reduced as it is observed from fig. 7. The result of fig. 5 proves that voltage oriented control strategy can be implemented on three level NPC inverter. The space vector modulation technique can be easily implemented with their sectors evaluation. The four switches in

one leg can be switched ON and OFF as per required. There will be a time interval at which only two switches will be turned ON while other will be turned OFF in one leg while implementing space vector modulation. Table no.2 gives idea about the component specifications shown below.

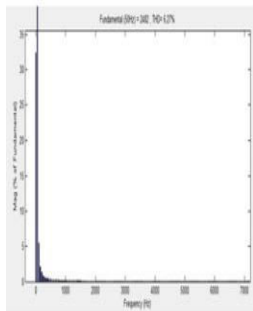

Fig 8. THD VOC PR controller (6.27%)

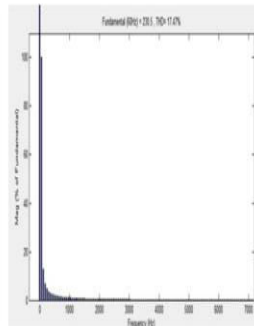

Fig 9. THD VOC PI controller (17.47%)

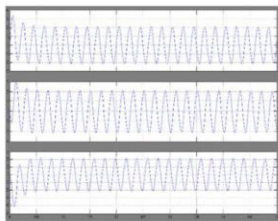

Fig 10. Filter Current

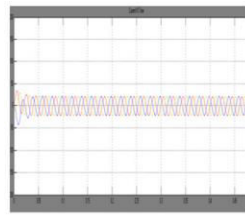

Fig 11. Steady state PR controller current

Table 2. Specifications

Sr.No.	Components	Rating
1.	PV DC voltage	220V
2.	Boost Voltage, Duty	415,47%
3.	Boost Inductor	5mH
4.	Filter Inductor	25mH
5.	K <sub>p</sub> ,K <sub>i</sub> (PI)	0.3,20
6.	K <sub>p</sub> ,K <sub>i</sub> , ω(PR)	100,200,0.01
7.	DC Capacitor	2200uF
8.	Grid ph-ph voltage	400Vrms

Table 3. Conclusion

Sr.No.	Parameters	PI Controller	PR Controller
1.	Inrush Current	High	Less
2.	No. of transformation stages	More	Less
3.	Computation Complexity	More	Less
4.	Total Harmonic Distortion	More	less
5.	Implementation	Simple	Complex
6.	Steady State Error	More	Minimized

## 4. Conclusion

The three level NPC inverter is successfully implemented with the help of space vector modulation using PR controller voltage oriented control strategy. The three level NPC inverter is simulated with PR controller using SVM technique. The DC capacitor balancing is achieved as there is no problem detected. The harmonic reduction is done at large scale and inrush current is minimized using PR controller. As when this topology is compared with the other topologies such as parallel inverters or two level VSI, this method has quite well advantageous. Moreover it reduces losses, reduction in cost and can be easily implemented. This strategy can be used for large scale generation as the grid is set to three phase grid integration. Table no. 3 shows the parameter comparison for PI controller and PR controller respectively

## References

- [1] Hossein Dehghani Tafti, Ali I. Maswood, Abhisek Ukil, Ooi H. P. Gabriel, Lim Ziyou, "NPC Photovoltaic Grid-Connected Inverter using Proportional-Resonant Controller", 978-1-4799-7537-2/14 IEEE.
- [2] Jeyraj Selvaraj and Nasrudin A. Rahim, "Multilevel Inverter For Grid-Connected PV System Employing Digital PI Controller", IEEE Transactions On Industrial Electronics, Vol. 56, No. 1, page no. 149-8, January 2009.
- [3] Keliang Zhou and Danwei Wang, "Relationship Between Space-Vector Modulation and Three-Phase CarrierBased PWM: A Comprehensive Analysis", IEEE Transactions On Industrial Electronics, Vol. 49, No. 1, page no.186-6, February 2002.
- [4] C. Bharatirajai, S. Raghu , R.Palanisami, "A New Space Vector Pulse width



Modulation for Reduction of Common Mode Voltage in Three Level Neutral Point Diode Clamped Multilevel Inverter”, IEEE - International Conference On Advances In Engineering, Science And Management (ICAESM -2012) , page no. 694-9, March 30, 31.

[5] Bengi Tolunay, Space Vector Pulse Width Modulation for Three-Level Converters”.

[6] Christian Alexandra<sup>1</sup>, Ali M. Almaktoof<sup>2</sup> and AK Raji<sup>3</sup>Electrical Engineering department, Cape Peninsula University of

Technology, “Development of a Proportional + Resonant (PR) Controller for a Three-Phase AC Micro-Grid System”, ISBN:978-0-9891305-3-0, SDIWC2013, page no.107-12.  
[7] R. Teodorescu, F. Blaabjerg, M. Liserre and P.C. Loh, “Proportional-resonant controllers and filters for gridconnected voltage-source converters”, IEE Proc. Electr. Power Appl., Vol. 153, No.5, page no. 750-61, September 2006.