



COPY RIGHT

2017 IJIEMR. Personal use of this material is permitted. Permission from IJIEMR must be obtained for all other uses, in any current or future media, including reprinting/republishing this material for advertising or promotional purposes, creating new collective works, for resale or redistribution to servers or lists, or reuse of any copyrighted component of this work in other works. No Reprint should be done to this paper, all copy right is authenticated to Paper Authors

IJIEMR Transactions, online available on 16th Aug 2017. Link

[:http://www.ijiemr.org/downloads.php?vol=Volume-6&issue=ISSUE-7](http://www.ijiemr.org/downloads.php?vol=Volume-6&issue=ISSUE-7)

Title: **PLAN AND IMPLEMENTATION OF MULTIBANDRECEIVING WIRE FOR 5G WIRELESS NETWORKS**

Volume 06, Issue 07, Pages: 229-234.

Paper Authors

B.SIVA NAGESWARARAO,DR,K.E.SRINIVASA MURTHY



USE THIS BARCODE TO ACCESS YOUR ONLINE PAPER

To Secure Your Paper As Per **UGC Guidelines** We Are Providing A Electronic Bar Code

PLAN AND IMPLEMENTATION OF MULTIBAND RECEIVING WIRE FOR 5G WIRELESS NETWORKS

¹B.SIVA NAGESWARARAO, ²DR. K.E.SRINIVASA MURTHY

¹Research scholar, Electronics and Communication Engineering, Rayalaseema University, Kurnool, A.P.,

²Principal, Sri Sai Institute of Technology and Science, Rayachoti, Y.S.R(Dist), A.P

ABSTRACT: This venture introduces the outline and execution of Multiband Antenna for 5G remote system. The 5G remote system will be the risen variant of the whole wired and remote system which incorporates intellectual radio system, Wi-Fi, satellite correspondence, WSN, Li-Fi, optical fiber system and Wi-Max. Here the radio wire is intended for a few administrations, for example, DCS(1.88GHz), WLAN(2.44GHz), WSN(2.45GHz), LTE(1.Hz), WiFi(2.68GHz), WiMax(6.45GHz), HIPERLAN2(5.25GHz), KuBand(712GHz). Thereception apparatus is composed utilizing the product - High Frequency Structure Simulator (HFSS).

Keyword: 5G network, LTE, Multiband antenna, WSN, WLAN.

1. INTRODUCTION

The most recent innovation is thought to be the brilliant receiving wire which can possibly build the framework execution. The keen radio wire can build the limit and scope, low power utilization and power interface quality, vitality productivity, ghastly effectiveness. These days contrasted with settled line correspondence the quantity of remote endorsers has been expanded. The capacities of 5G remote get to must reach out to empower the availability for an extensive variety of new applications contrasted with the past eras of portable correspondence. For instance the abilities, for example, low inertness, to deal with outrageous gadget densities, high information rates, high Dependability and improvement of LTE in mix with new radio get to innovation. The first generation of wireless telephone and mobile telecommunication refers to 1G it was

introduced in 1980 and used AMPS (analog signal) were first launched in USA up to 2.4kbps. Hence the communication migrated from analog to digital 8, the foundation led the latest communication to 2G. The second generation is based on GSM which was launched in 1991 and use digital signal its data speed was 64kbps it enables service such as text message and MMS but it requires strong digital signals better performance. 2G has been superseded by technology known as 2.5G it is described as GPRS combined with 2G cellular technology. Next is the 3G, the third generation which was In mobile communication 5G will be the next step in the evolution and the network society will be the key component and help the vision of unlimited access to information and data sharing anytime for anyone. The 5G aimed

to provide ubiquitous connectivity for all devices and any application which benefits for their connectivity. 5G will extend the range of frequency used for mobile communication and the best way to help the entire user is to use the 5G as the next wireless system it is totally safety and secure for public. 5G is a packet switched wireless system with wide area coverage and high throughput the 5G technology uses CDMA millimeter wireless that enables speed greater than 100Mbps at full mobility and higher than 1Gbps at low mobility. Basically each antenna operates in a single or dual frequency band, where different antenna is used for various applications which lead to a limited space problem. In order to avoid this problem multiband antenna can be used where Single antenna operated for multi frequency band. This project presents the multiband rectangular antenna as well as the theoretical design procedure and numerical simulations are performed using the HFSS (High frequency structure simulator) to obtain the design parameters. The antenna has the greater potential in ultra wideband application, multi frequency, and antenna miniaturization. The communication system has been currently developed to broadband so that people needs for portable mobile communication. In modern communication the need of antenna requirement can be achieved using then antenna such as thin section, low price, being easy to manufacture and small size.

2. LITERATURE REVIEW

The research done by [1] novel triangular fractal antenna for X band (8GHz), k band (12 GHz) gives the performance for tri-band

antenna. The antenna efficiency of antenna is very good and it gives from 55-80% and its gain fluctuates from 2.6-5.3 dBi over three bands. A new fractal antenna [2] is designed and simulated using HFSS software here the geometry antenna satisfies all the conditions for different frequency 1 GHz to 10GHz it is applicable for radio communication but it has a limitation of radiation efficiency. In article [3] coplanar waveguide fed fractal antenna is suitable for multiband applications. The fractal heptagonal array antenna provides the miniaturization and wide band application. Antenna radiates centre frequency 9GHz it has a low profile, optimum impedance matching, low VWSR values and Omni directional radiation pattern. In hybrid fractal shape monopole antenna [4] it covers the multiple wireless communication bands and for handheld mobile devices. Thus the antenna proposed in this paper works at several bands where the resonant frequency operates till 12GHz using the reflector which is embedded at the top of the patch.

3. MATERIALS AND METHODS

Here the project is designed and simulated using the HFSS (High frequency structure simulator). The HFSS is an interactive simulation system and it allows you to solve any arbitrary 3D geometry, mainly those with complex curves and shapes, in a fraction of time. Ansoft HFSS employ adaptive meshing, Finite Element Method (FEM). The HFSS is used to calculate parameters such as S Parameters, Resonant Frequency. HFSS is a high performance.

3.1 Design Modelling

Here we use a single antenna to cover the number of applications or services; a modified multiband fractal antenna structure is designed and the antenna substrate dimension is given in the table.

Table.1: Antenna substrate dimension

ϵ_r	L(mm)	W(mm)	h(mm)
4.6	38	43	1.588

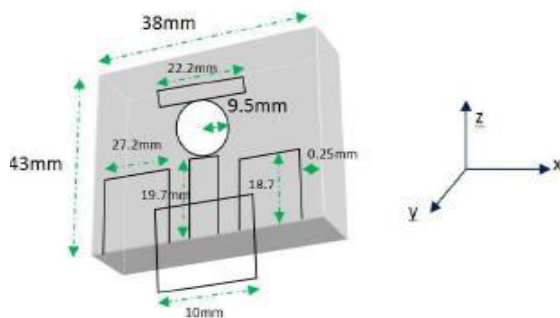

Fig.1: Antenna structure

The antenna design block is constructed using the rectangular (reflector) and the circular patch antenna. A patch antenna is a wide beam antenna and narrowband which is fabricated by the antenna element pattern a common Microstrip antenna shapes are circular, square, rectangular, and elliptical. The rectangular patch looks like a truncated Microstrip transmissionLine the most commonly employed micro strip antenna. L is the resonant dimension (current flow direction). In Circular Patch Antenna the feed location Determines the current flow direction and so the polarization of the radiated field.

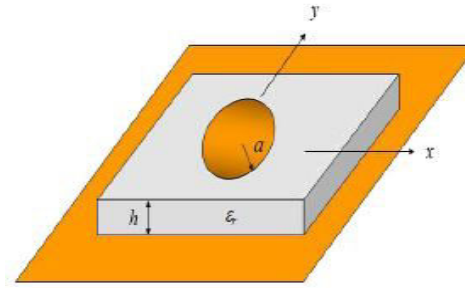

Fig.2: Circular Patch Antenna

In circular patch antenna the modes support can be found by treating the patch, ground plane, and the material between the two as a circular cavity.

3.2 Design Equation Rectangular Patch Antenna

Width

$$W = \frac{V_0}{2f_0} \sqrt{\frac{2}{\epsilon_r + 1}}$$

Efficient dielectric constant

$$\epsilon_{reff} = \frac{\epsilon_r + 1}{2} + \frac{\epsilon_r - 1}{2} \left[1 + 12 \frac{h}{w} \right]^{-\frac{1}{2}}$$

Actual Length of patch (L)

$$L = L_{eff} - 2\Delta L$$

Ground Plane Dimension

$$L_g = 6h + L$$

$$W_g = 6h + w$$

Effective length

$$L_{eff} = \frac{v_0}{2f_0 \sqrt{\epsilon_{reff}}}$$

Decrement length

$$\Delta_L = 0.412 h \frac{(\epsilon_{reff} + 0.3) \left(\frac{W}{h} + 0.264\right)}{(\epsilon_{reff} - 0.258) \left(\frac{W}{h} + 0.8\right)}$$

3.3 Design Equation of a Circular Patch Antenna

$$a = F \left\{ 1 + \frac{2h}{\pi F \xi_r} \left[\ln \left(\frac{\pi F}{2h} \right) + 1.7726 \right] \right\}^{-\frac{1}{2}}$$

$$F = \frac{8.791 \times 10^9}{f_r \sqrt{\xi_r}}$$

4. PROPOSED WORK

In this paper the proposed work aims to operate the multiband fractal antenna for atleast seven converged wireless network service. Here a new multiband antenna is designed using the HFSS software and the geometry antenna satisfies all the conditions for different frequency band. It is noted that the antenna is wideband and it is applicable for radio communication and in many wireless application. Here the single multiband antenna covers more than 5 wireless network services such as DCS (1.88GHz), LTE(1.9GHz), WLAN (2.45GHz), HIPER LAN2(5.25GHz), Wi-Max(5.45GHz) and Ku Band (12GHz) applications. Thus the multiband fractal antenna play a leading role in wireless communication system and the designed antenna works for multiple frequency bands as compared to other antenna it proves to be a perfect candidate with its characteristics such as high gain, directivity and return loss

5. RESULT

The designing of the antenna is made using HFSS and the figure shows the simulation result. The resonant frequency of the

antenna is described by the key parameters such as return loss and VSWR.

5.1 S-Parameter

The figure shows the proposed antenna resonates for six frequency bands.

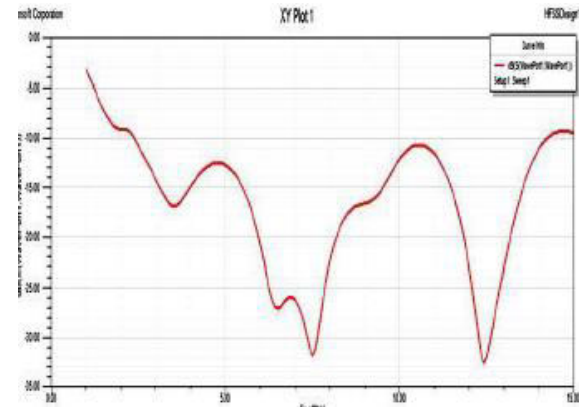

5.2 3d Polar Plot

In the field of antenna design the term radiation pattern (or antenna pattern or farfield pattern) refers to the directional (angular) dependence of the strength of the radio waves from the antenna or other source.

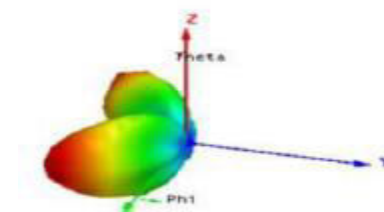
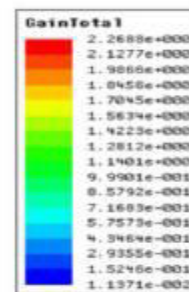

5.4 Radiation Pattern

Radiation boundaries, also referred to as absorbing boundaries, enable to model a

surface as electrically open waves can then radiate out of the structure and toward the radiation boundary. frequency range of 12.43GHz for „0degree“ is shown in the figure.

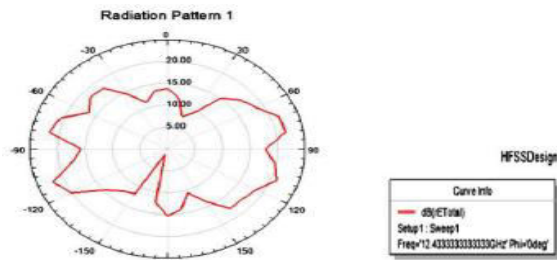

(i) Thus radiation pattern for the Highest frequency range of 12.43GHz for 90degree“ is shown in the figure.

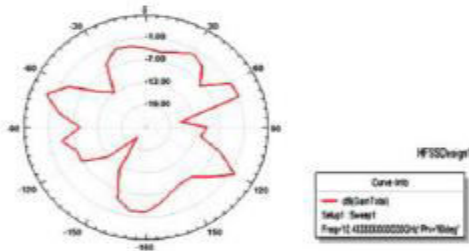

5.3 VSWR

VSWR stands for Voltage Standing Wave Ratio, and is also referred to as Standing Wave Ratio (SWR). VSWR is a function of the reflection coefficient, which describes the power reflected from the antenna. Thus radiation pattern for the lowest frequency range of 3.433 GHz for „0degree“ is shown in the figure

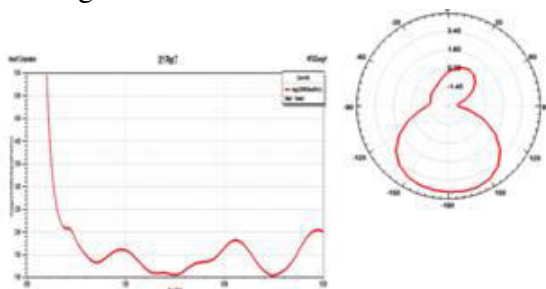

ii) Thus radiation pattern for the lowest frequency range of 3.473GHz for 90degree“ is shown in the figure

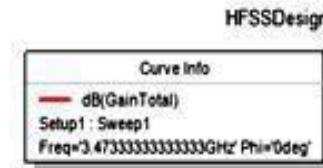

6. CONCLUSION

The proposed multiband antenna resonates at the frequency of 1.88GHz, 2.45GHz, 1.4GHz, 6.45GHz, 5.25GHz and 12GHz bands with a reasonable return loss and omnidirectional radiation pattern. Hence it suits for the wireless application such as antenna DCS (1.88GHz), WLAN (2.45GHz), LTE (1.9GHz), WiMAX (6.45GHz), HIPER LAN2 (5.25GHz) and Ku Band (12GHz) application.

REFERENCES

- [1] Benoit B. Mandelbrot, The Fractal Nature of Geometry, New York, W. H. Freeman and company, 1977.
- [2] Ved Vyas Dwivedi, Ph. D. Thesis, ‘Design and Development of Dual/Tri band miniaturized and compact antenna using metamaterial’, 2010
- [3] P.E. Mayes, Frequency-independent antenna and broad-band derivatives thereof, Proc IEEE 80, 1992, 1103–1123.
- [4] C. Puente, J. Romeu, R. Pous, and A. Cardma, On the behavior of the Sierpinski multiband fractal antenna, IEEE Trans Antennas Propagat AP-46, 1998, 517–524.
- [5] J. Parron, J. M. Rius, and J. Romeu, “Improving the performance of method of moments for the analysis of fractal antennas,” in Antennas Non-Standard Techniques et Traitements, Journées SEE,



Paris, France, Mar. 2000.

[6] FRACTAL-SHAPE SMALL SIZE MICROSTRIP PATCHES ANTENNA II- Kwon Kim, Jong-Gwan Yook, and Han-Kyu Park Department of Electrical and Electronics

Yonsei University Seoul, Korea, 2002

[7] S. Siva Sundara Pandian,

C. D. Suriyakala, "A

Novel Multiband Sierpinski Triangular Fractal Antenna For Cognitive Radio", 2013 2013

International Conference On Circuits, Power And Computing Technologies ICCPCT- 2013, PP. 803-807

[8] B. Hephzibah Lincy, A. Srinivasan, B. Rajalakshmi. "Wideband Fractal Microstrip Antenna for Wireless Application". Proceedings of 2013 IEEE

Conference on Information and Communication Technologies ICT 2013, ISBN-978-1-4673-5758-6, PP-735-738

[9] Muhammad Naem Iqbal, Hamood-Ur-Rahman, Syeda Fizzah Jilani, "Novel Compact Wide Band Coplanar Waveguide Fed Heptagonal Fractal Monopole Antenna for Wireless Applications", ISBN-978-1-4673-5537-7, 2013.

[10] Yogesh Kumar Choukiker, Satish K. Sharma, and Santanu K. Behera, "Hybrid Fractal Shape Planar Monopole Antenna Covering Multiband Wireless Communications, With MIMO Implementation For Handheld Mobile Devices", IEEE Transactions On Antennas And Propagation, Vol. 62, No. 3, 2014, page-1483-1488

[11] Yuming Nie, Lizhong Song, "A Compact Triband Fractal Pifa Antenna for Mobile Handset Applications", 2013 6th International Congress on Image and Signal Processing CISP 2013. 978-1-4799-2764-7, 2013. PP-1468-1472

[12] A. Kulkarni and S. K. Sharma, "A multiband antenna with MIMO implementation for USB dongle size wireless devices," *Microw. Opt. Technol. Lett.*, vol. 54, no. 8, pp. 1990–1994, Aug. 2012

[13] Liu Ying et al, "Microstrip Fractal Patch Antenna for Multi-Band Communication," IEEE 23rd International Conference on Microwave and Millimeter Wave Technology Proceedings, pp. 600-602, 2002.

[14] A. Azari, "Super Wideband Fractal Antenna Design," presented at the IEEE MAPE 2009, Beijing, China.

[15] N. Cohen, "Fractal Antenna Applications in Wireless Telecomm.," In Proc. Professional Program Elect. Industry Forum 1997, pp. 43-49.

[16] N. Cohen, "Fractal Antenna Applications in Wireless Telecomm.," In Proc. Professional Program Elect. Industry Forum 1997, pp. 43-49.

[17] N. Cohen, "Fractal Antenna Applications in Wireless Telecomm.," In Proc. Professional Program Elect. Industry Forum 1997, pp. 43-49.

[18] N. Cohen, "Fractal Antenna Applications in Wireless Telecomm.," In Proc. Professional Program Elect. Industry Forum 1997, pp. 43-49.