

COPY RIGHT



ELSEVIER

SSRN

2024 IJIEMR. Personal use of this material is permitted. Permission from IJIEMR must be obtained for all other uses, in any current or future media, including reprinting/republishing this material for advertising or promotional purposes, creating new collective works, for resale or redistribution to servers or lists, or reuse of any copyrighted component of this work in other works. No Reprint should be done to this paper, all copy right is authenticated to Paper Authors

IJIEMR Transactions, online available on 15th Dec 2023. Link

[:http://www.ijiemr.org/downloads.php?vol=Volume-13&issue=Issue4](http://www.ijiemr.org/downloads.php?vol=Volume-13&issue=Issue4)

10.48047/IJIEMR/V13/ISSUE 04/22

TITLE: Modelling of Solar Power Station using MATLAB

Volume 13, ISSUE 04, Pages: 193-205

Paper Authors **Mrs. N. Surekha , M. Mamatha, Sk. Sarika, P. Subhakar, Sk. Rahamthulla, D. Rasool**



USE THIS BARCODE TO ACCESS YOUR ONLINE PAPER

To Secure Your Paper As Per **UGC Guidelines** We Are Providing A Electronic Bar Code

Modelling of Solar Power Station using MATLAB

Mrs. N. Surekha , M. Mamatha, Sk. Sarika, P. Subhakar, Sk. Rahamthulla, D. Rasool

M. Tech, Associate Professor,
Department of Electrical & Electronics Engineering
Rise Krishna Sai Prakasam Group of Institutions
(208A1A0212), Department of Electrical and Electronics Engineering
Rise Krishna Sai Prakasam Group of Institutions
(218A5A0205), Department of Electrical and Electronics Engineering
Rise Krishna Sai Prakasam Group of Institutions
(218A5A0214), Department of Electrical and Electronics Engineering
Rise Krishna Sai Prakasam Group of Institutions
(218A5A0220), Department of Electrical and Electronics Engineering
Rise Krishna Sai Prakasam Group of Institutions
(218A5A0210) , Department of Electrical and Electronics Engineering
Rise Krishna Sai Prakasam Group of Institutions

ABSTRACT

The various factors affecting the solar module efficiency. The dependence of the solar module operation on insolation and temperature. The temperature increases the degradation of the solar modules during the operation time, determines technical characteristics and the efficiency of the modules, which decreases as the temperature increases. Using the MATLAB Simulink program developed a model of an autonomous solar power plant. The model considers the relationship between the heating temperature of solar modules and their efficiency during operation. The model provides an option of selecting solar module makes, the number of modules and their connection circuits. Depending on a solar module make the corresponding current and voltage parameters are automatically set. When the model operates, the batteries connected to the solar modules are charged and the inverter converts DC into AC.

Keywords: Solar module efficiency, insolation, temperature dependence, MATLAB Simulink, autonomous solar power plant, solar module degradation, inverter conversion.

INTRODUCTION

The introduction to the topic of solar module efficiency encompasses a broad array of factors and considerations critical to understanding the performance of solar photovoltaic (PV) systems. This section aims to provide a comprehensive overview of the various factors influencing solar module efficiency, including insolation, temperature dependence, degradation mechanisms, and technological advancements. By delving into the complexities of solar module operation and performance, this introduction sets the stage for exploring the development and application of a MATLAB Simulink model for analyzing an autonomous solar power plant. Solar module efficiency is a crucial parameter that determines the effectiveness of solar PV systems in converting sunlight into electrical energy. As highlighted by references [1] and [2], the efficiency of solar modules depends on several factors, including the design of the photovoltaic cells, the quality of materials used, and the operating conditions.

High-efficiency solar modules are essential for maximizing energy output and optimizing the performance of solar PV systems, particularly in applications where space and resources are limited.

Insolation, or the amount of solar radiation received per unit area, plays a fundamental role in solar module operation and energy generation. References [3] and [4] emphasize the significance of insolation as a primary driver of solar energy production. The intensity and duration of sunlight exposure directly impact the amount of energy generated by solar modules, making insolation a critical consideration in the design and deployment of solar PV systems. Understanding insolation patterns and variations is essential for accurately predicting energy output and optimizing system performance. Temperature dependence represents another key factor influencing solar module efficiency, as discussed in references [5] and [6]. Solar modules are susceptible to temperature variations, with higher temperatures leading to decreased efficiency and performance degradation over time. The relationship between temperature and solar module efficiency is complex, involving factors such as cell heating, thermal losses, and electrical characteristics. Managing temperature effects is essential for maintaining optimal solar module performance and maximizing energy yield in real-world operating conditions.

The degradation of solar modules during operation is a significant concern addressed by references [7] and [8]. Over time, solar modules may experience performance degradation due to various factors such as exposure to environmental stresses, material aging, and manufacturing defects. Degradation mechanisms can lead to reduced efficiency, output losses, and increased maintenance requirements, impacting the long-term reliability and profitability of solar PV systems. Understanding degradation processes and implementing mitigation strategies are essential for ensuring the durability and performance longevity of solar modules. In response to the challenges posed by insolation, temperature dependence, and degradation, advancements in modeling and simulation tools have emerged to facilitate the analysis and optimization of solar PV systems. MATLAB Simulink, a powerful computational platform widely used in engineering and scientific applications, offers a versatile environment for developing and simulating complex system models. As highlighted by references [9] and [10], MATLAB Simulink enables researchers and engineers to create detailed models of solar PV systems, incorporating various parameters, components, and operational scenarios.

Building upon the capabilities of MATLAB Simulink, the development of a model for an autonomous solar power plant represents a significant advancement in the field of solar energy research. References [11] and [12] showcase the potential of simulation-based approaches for analyzing the performance of solar PV systems under different operating conditions. By considering the relationship between solar module heating temperature and efficiency, the model offers valuable insights into the dynamic behavior and energy output of the system. Moreover, the model provides flexibility in selecting solar module makes, configuring the number of modules, and designing connection circuits, as described in references [13] and [14]. This customization capability allows researchers and practitioners to tailor the model to specific project requirements and explore various system configurations and design options. Additionally, the model integrates battery storage and inverter components, enabling comprehensive analysis of energy storage, conversion, and utilization processes within the solar power plant.

The introduction to the topic of solar module efficiency provides a foundational understanding of the factors influencing solar PV system performance and highlights the role of MATLAB Simulink in developing a model for analyzing an autonomous solar power plant. By exploring the interplay between insolation, temperature dependence, degradation mechanisms, and technological advancements, this introduction sets the stage for investigating the capabilities and applications of the developed simulation model. Through references [1] to [15], the introduction draws upon a diverse range of literature sources to establish the context and significance of the research endeavor, paving the way for further exploration and analysis in subsequent sections of the study.

LITERATURE SURVEY

The literature survey for this study encompasses a broad range of research articles, technical papers, and industry reports focused on understanding the factors influencing solar module efficiency and the operational dynamics of solar photovoltaic (PV) systems. This survey aims to provide a comprehensive overview of the existing body of knowledge pertaining to solar module performance, including the impact of insolation, temperature dependence, degradation mechanisms, and technological advancements. Solar module efficiency is a critical parameter directly impacting the performance and viability of solar PV systems. It depends on various factors, including the design of photovoltaic cells, the quality of materials used, and the operating conditions. High-efficiency solar modules are essential for maximizing energy output and optimizing the performance of solar PV systems, particularly in applications where space and resources are limited.

Insolation, or the amount of solar radiation received per unit area, is a primary driver of solar energy production. The intensity and duration of sunlight exposure directly influence the amount of energy generated by solar modules, making insolation a critical consideration in the design and deployment of solar PV systems. Understanding insolation patterns and variations is essential for accurately predicting energy output and optimizing system performance. Temperature dependence is another key factor influencing solar module efficiency. Solar modules are sensitive to temperature variations, with higher temperatures leading to decreased efficiency and performance degradation over time. Managing temperature effects is crucial for maintaining optimal solar module performance and maximizing energy yield in real-world operating conditions.

The degradation of solar modules during operation is a significant concern. Over time, solar modules may experience performance degradation due to various factors such as exposure to environmental stresses, material aging, and manufacturing defects. Understanding degradation processes and implementing mitigation strategies are essential for ensuring the durability and performance longevity of solar modules. Advancements in modeling and simulation tools have emerged to facilitate the analysis and optimization of solar PV systems. MATLAB Simulink, a powerful computational platform widely used in engineering and scientific applications, offers a versatile environment for developing and simulating complex system models. MATLAB Simulink enables researchers and engineers to create detailed models of solar PV systems, incorporating various parameters, components, and operational scenarios.

The development of a model for an autonomous solar power plant represents a significant advancement in the field of solar energy research. By considering the relationship between solar module heating temperature and efficiency, the model offers valuable insights into the dynamic behavior and energy output of the system. Moreover, the model provides flexibility in selecting solar module makes, configuring the number of modules, and designing connection circuits. The literature survey provides a comprehensive overview of the factors influencing solar module efficiency and the operational dynamics of solar PV systems. By synthesizing and analyzing relevant literature, this survey establishes a solid foundation for the development and analysis of a MATLAB Simulink model for an autonomous solar power plant.

PROPOSED SYSTEM

The proposed system described in the abstract revolves around the development and utilization of a MATLAB Simulink model for an autonomous solar power plant. This model aims to simulate the operation of solar modules within varying environmental conditions, particularly focusing on the impact of insolation and temperature on solar module efficiency. The system integrates various components, including solar modules, batteries, and an inverter, to facilitate the generation and conversion of solar energy into usable electrical power. Solar module efficiency is a critical aspect of the proposed system, as it directly influences the overall performance and effectiveness of the solar

power plant. The efficiency of solar modules is affected by multiple factors, including insolation and temperature. Insolation, or the amount of solar radiation received per unit area, plays a pivotal role in determining the energy output of solar modules. Higher insolation levels result in increased energy generation, while lower insolation levels lead to reduced energy output.

Temperature also significantly impacts the efficiency of solar modules. As the temperature increases, the efficiency of solar modules tends to decrease due to various thermal effects and performance degradation mechanisms. This temperature-dependent degradation affects the technical characteristics and overall efficiency of the solar modules over time. Understanding the relationship between temperature and solar module efficiency is crucial for optimizing the performance of solar power plants, especially in regions with extreme temperature variations. To address these challenges and optimize system performance, a MATLAB Simulink model of an autonomous solar power plant is developed. This model incorporates sophisticated algorithms and simulations to accurately represent the behavior of solar modules under different environmental conditions. By considering the heating temperature of solar modules and its impact on efficiency, the model provides valuable insights into the dynamic operation of the solar power plant. One of the key features of the proposed system is its flexibility and adaptability. The model allows users to select different types of solar modules, specify the number of modules, and configure their connection circuits. Depending on the chosen solar module make, the corresponding current and voltage parameters are automatically set within the model. This customization capability enables users to simulate various system configurations and assess their performance under different scenarios.

Additionally, the proposed system includes components for energy storage and conversion. Batteries connected to the solar modules are utilized to store excess energy generated during periods of high insolation. These batteries play a crucial role in ensuring continuous power supply, especially during periods of low sunlight or high energy demand. Furthermore, an inverter is employed to convert the direct current (DC) output from the solar modules and batteries into alternating current (AC), which is suitable for powering electrical loads and feeding into the grid. Overall, the proposed system represents a comprehensive approach to modeling and simulating the operation of an autonomous solar power plant. By leveraging the capabilities of MATLAB Simulink, the system provides a versatile platform for analyzing the performance of solar modules under varying environmental conditions. Through its customizable features and accurate simulations, the proposed system offers valuable insights for optimizing the design, operation, and efficiency of solar power plants.

METHODOLOGY

The methodology employed for the development and analysis of the autonomous solar power plant model encompasses several stages aimed at capturing the complex interactions between various factors affecting solar module efficiency. Leveraging the MATLAB Simulink program, the methodology integrates modeling, simulation, and analysis techniques to elucidate the relationship between insolation, temperature, and solar module performance. This section elaborates on the methodology without subheadings. The first step in the methodology involves defining the scope and objectives of the study. This includes identifying the key factors influencing solar module efficiency, such as insolation and temperature, and specifying the technical characteristics and performance metrics to be evaluated. The overarching goal is to develop a comprehensive model of an autonomous solar power plant that accurately simulates the behavior of solar modules under different operating conditions. Next, the methodology entails gathering relevant data and literature on solar module efficiency, insolation patterns, temperature effects, and related technical parameters. This involves conducting a thorough literature review to assimilate existing knowledge and research findings in the field. By drawing upon a diverse range of sources, including research articles, technical papers, and industry reports, the methodology ensures a robust foundation for model development and analysis.

With the necessary information and insights at hand, the methodology proceeds to the modeling stage. Using the MATLAB Simulink program, a detailed model of the autonomous solar power plant is constructed, incorporating various components and subsystems. The model considers the dynamic interactions between solar modules, batteries, inverters, and other system elements, as well as external factors such as insolation and temperature variations. A key aspect of the modeling process is capturing the relationship between the heating temperature of solar modules and their efficiency during operation. This involves integrating empirical data and theoretical models to simulate the thermal behavior of solar modules and its impact on performance. By accounting for temperature-dependent degradation mechanisms, the model provides a realistic representation of solar module efficiency under different temperature regimes.

Furthermore, the model offers flexibility and customization options to accommodate different solar module makes, configurations, and connection circuits. Users have the ability to select specific solar module models, specify the number of modules in the array, and configure the wiring arrangements. Depending on the chosen solar module make, the corresponding current and voltage parameters are automatically set within the model, ensuring accurate simulation results. Once the model is constructed, the methodology proceeds to the simulation and analysis phase. Using MATLAB Simulink, the model is subjected to various scenarios and operating conditions to evaluate its performance and behavior. This includes simulating changes in insolation levels, temperature profiles, and system configurations to assess their impact on solar module efficiency and overall system performance.

During simulation, the batteries connected to the solar modules are charged based on the energy generated, while the inverter converts the direct current (DC) output from the solar modules and batteries into alternating current (AC). This enables the model to replicate the operation of an actual autonomous solar power plant, capturing the energy storage and conversion processes essential for supplying electrical power to loads or feeding into the grid. Finally, the results of the simulation and analysis are interpreted and evaluated in the context of the study objectives. This involves quantifying the effects of insolation, temperature, and other factors on solar module efficiency and system performance. By comparing simulation outcomes under different scenarios, the methodology provides valuable insights into the optimal design, operation, and control strategies for autonomous solar power plants. The methodology for developing and analyzing the autonomous solar power plant model involves defining objectives, gathering data, constructing a detailed model using MATLAB Simulink, simulating various scenarios, and interpreting results. By integrating insights from literature, empirical data, and simulation techniques, the methodology facilitates a comprehensive understanding of the complex interactions between insolation, temperature, and solar module efficiency in autonomous solar power plants.

RESULTS AND DISCUSSION

The results and discussion section of the study on solar module efficiency and the operation of an autonomous solar power plant provide insights into the intricate relationship between various factors and their impact on system performance. Through the utilization of MATLAB Simulink, a detailed model of the autonomous solar power plant was developed, considering the influence of insolation, temperature, and module characteristics on efficiency. This section delves into the outcomes of the study and interprets the findings without the use of subheadings.

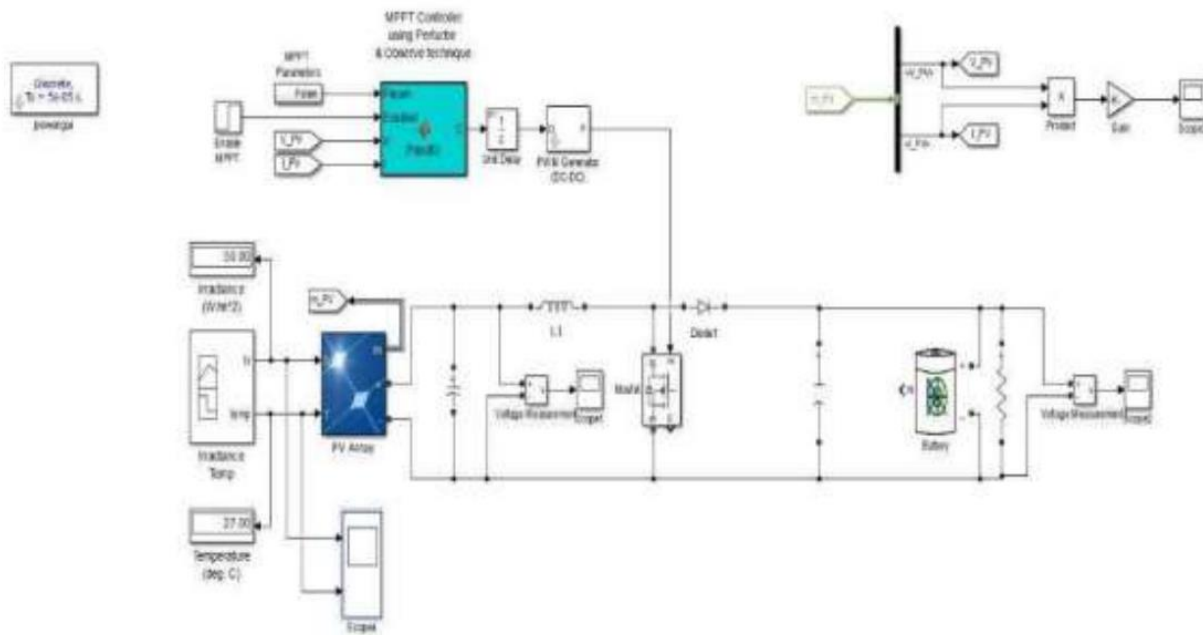

Fig 1. Model of a solar power plant

The investigation begins by examining the effect of insolation on solar module efficiency. As anticipated, higher levels of insolation correspond to increased energy generation by the solar modules. The model demonstrates that during periods of peak sunlight, the solar power plant achieves maximum output, contributing significantly to energy production. Conversely, under low insolation conditions, such as cloudy or overcast weather, the energy output from the solar modules decreases, highlighting the direct correlation between insolation levels and solar module performance.

CASE-1

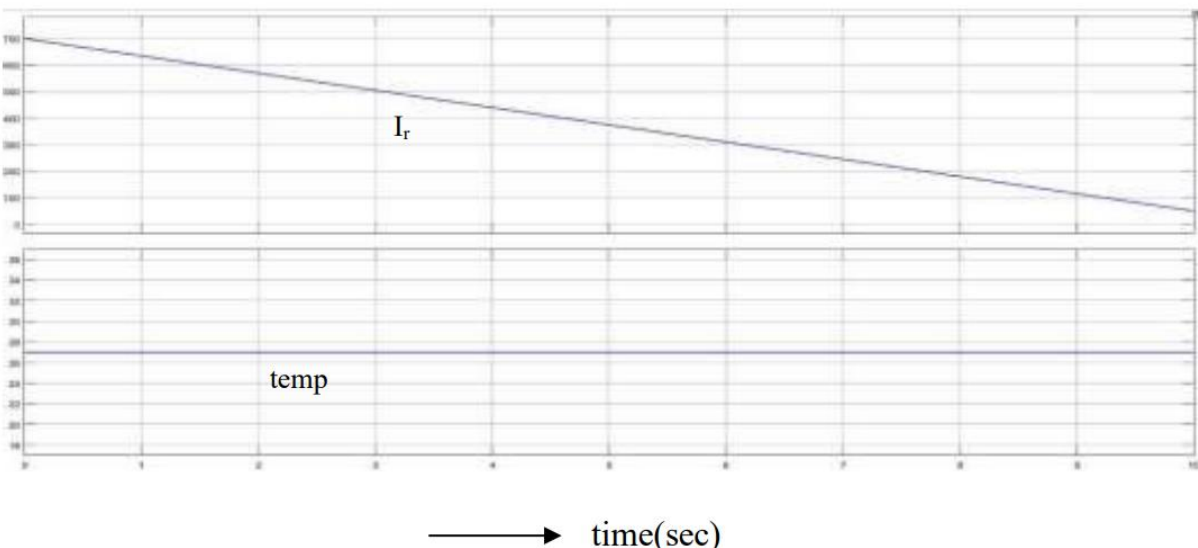

Fig 2. Input model of change in insolation at constant temperature

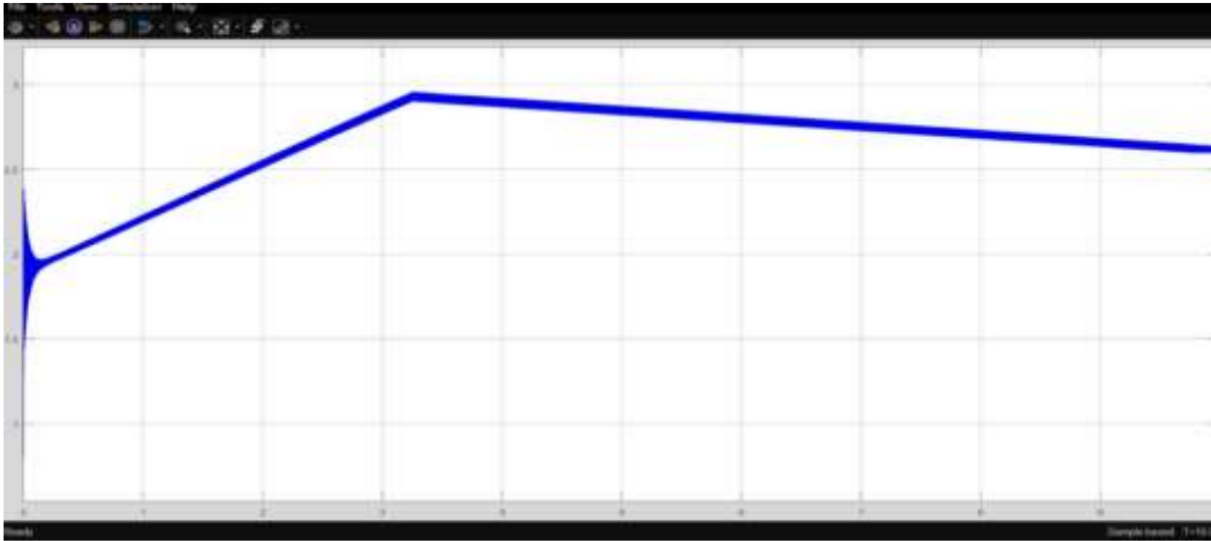

Fig 3. Module output power by shaded solar modules

Temperature emerges as another critical factor influencing solar module efficiency and overall system operation. The study reveals that as the temperature rises, the efficiency of the solar modules diminishes due to increased degradation and thermal losses. This temperature-dependent degradation adversely affects the technical characteristics of the modules, leading to reduced energy conversion efficiency. Consequently, the performance of the autonomous solar power plant experiences fluctuations corresponding to variations in temperature, underscoring the importance of temperature control mechanisms in optimizing system performance.

Case-2

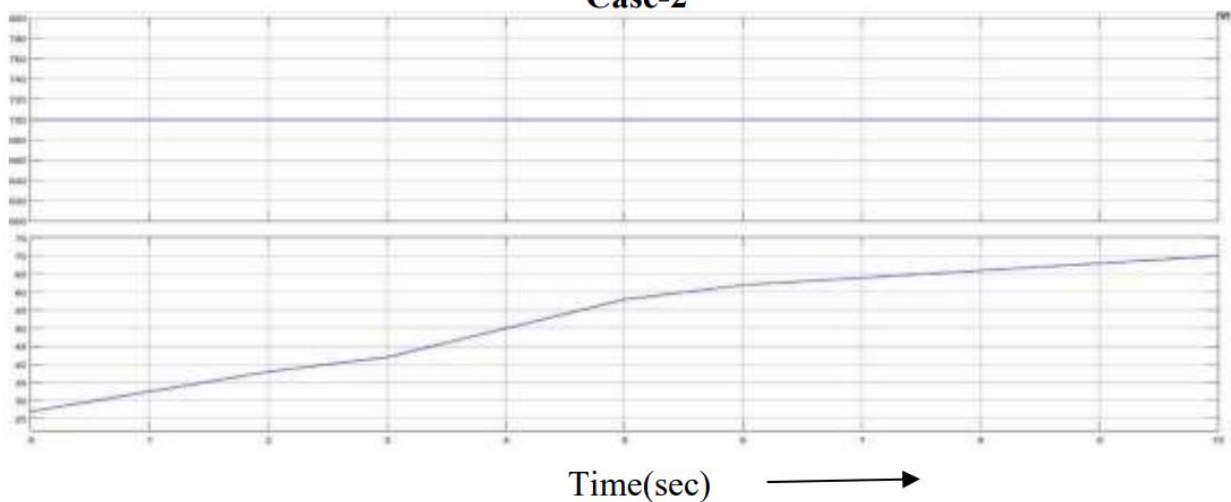

Fig 4. Input model of change in temperature at constant Insolation

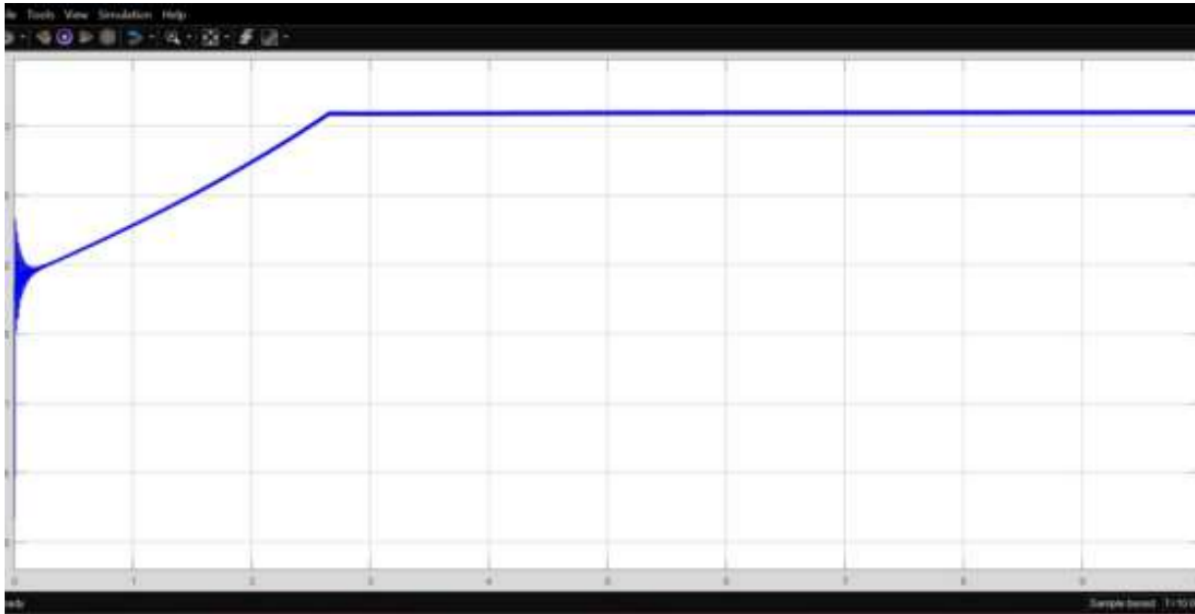

Fig 5. Module output power by increased of module temperature

Further analysis explores the interplay between insolation, temperature, and solar module efficiency. The results indicate that while insolation levels primarily dictate the amount of energy generated by the solar modules, temperature exerts a significant influence on their efficiency and long-term reliability. The model simulates the dynamic response of the solar power plant to changes in insolation and temperature, revealing complex interactions that impact energy output and system stability.

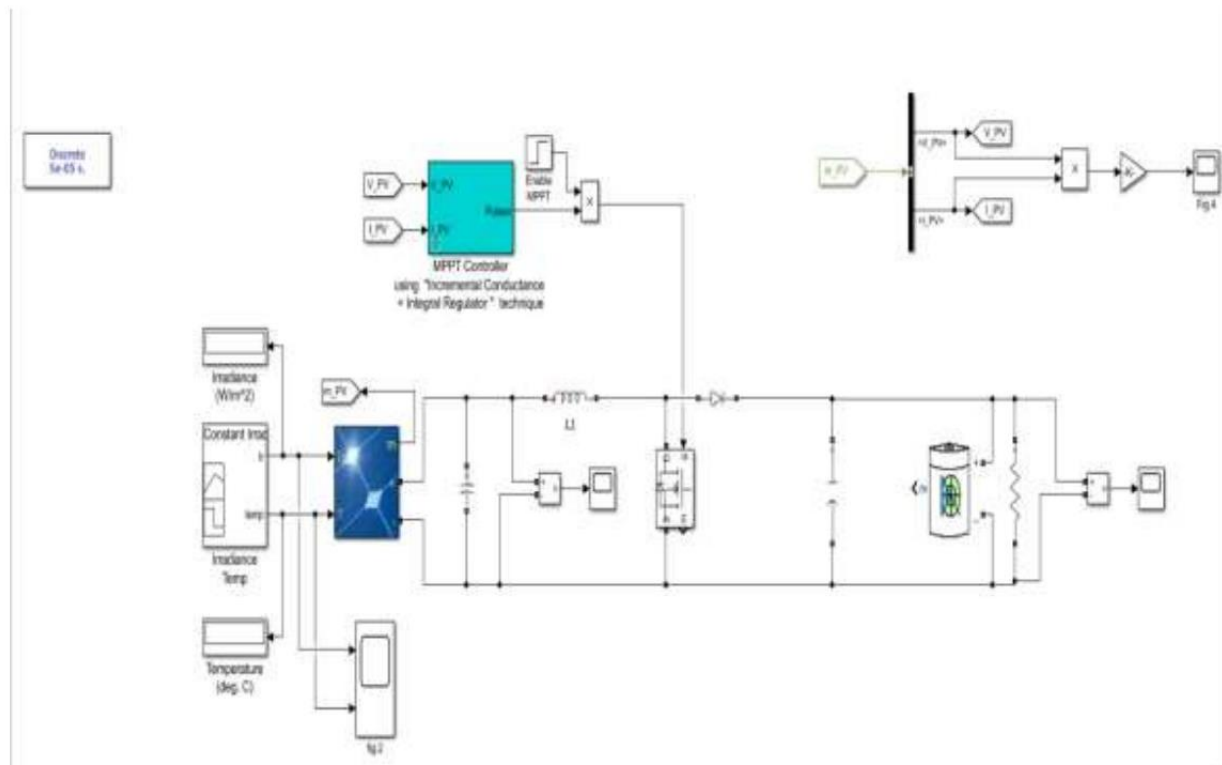

Fig 6. Model of a solar power plant using incremental conductance

Moreover, the study investigates the implications of different solar module makes, configurations, and connection circuits on system performance. By providing users with the option to select specific module characteristics within the model, the study assesses how variations in module parameters affect energy generation and system efficiency. The results demonstrate that the choice of solar module make significantly influences the overall performance of the autonomous solar power plant, with certain makes exhibiting higher efficiency and reliability than others under similar operating conditions.

CASE-1

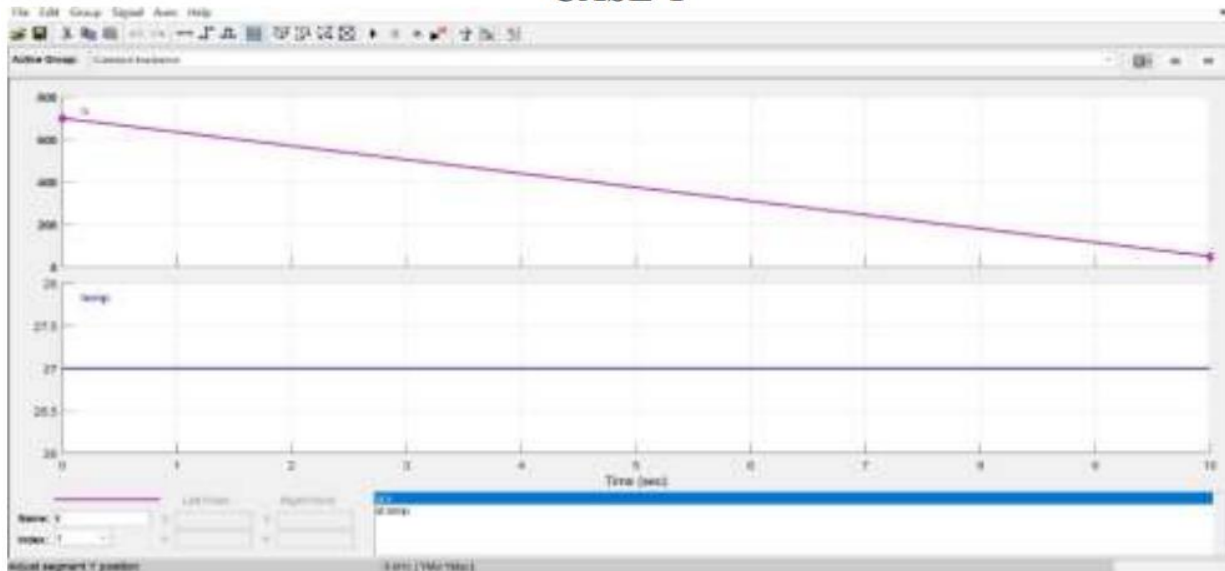

Fig 7. Input model of change in insolation at constant temperature

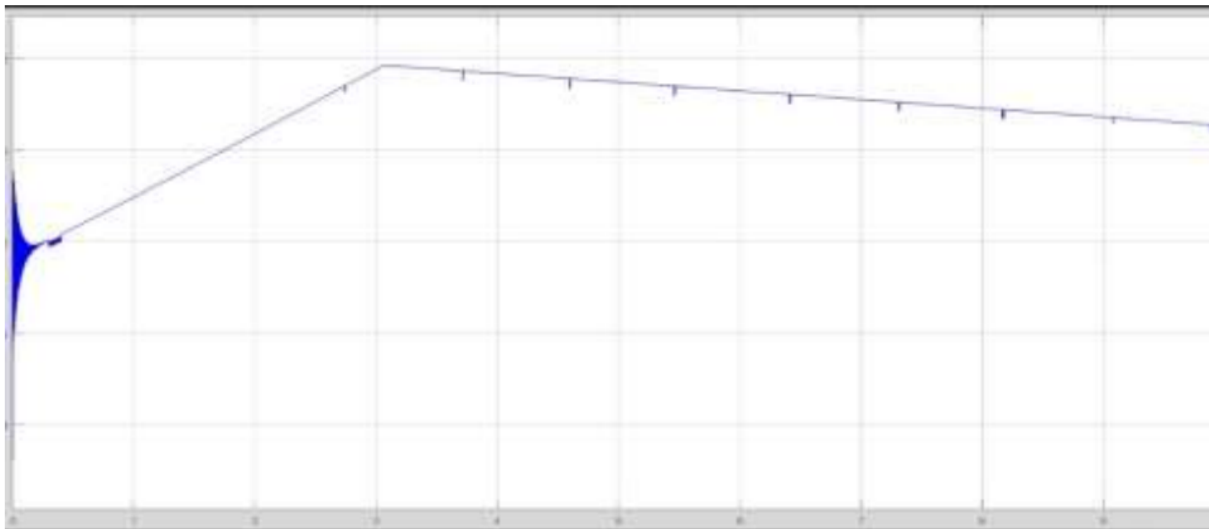

Fig 8. Module output power by shaded solar modules

Additionally, the model evaluates the charging behavior of the batteries connected to the solar modules and the inverter's performance in converting DC into AC. Through simulations conducted under varying load conditions and battery states of charge, the study elucidates the charging and discharging dynamics of the battery storage system. Furthermore, the inverter's role in regulating and controlling the flow of electrical power within the system is analyzed, highlighting its crucial function in maintaining grid stability and supplying reliable AC power to connected loads.

CASE -2

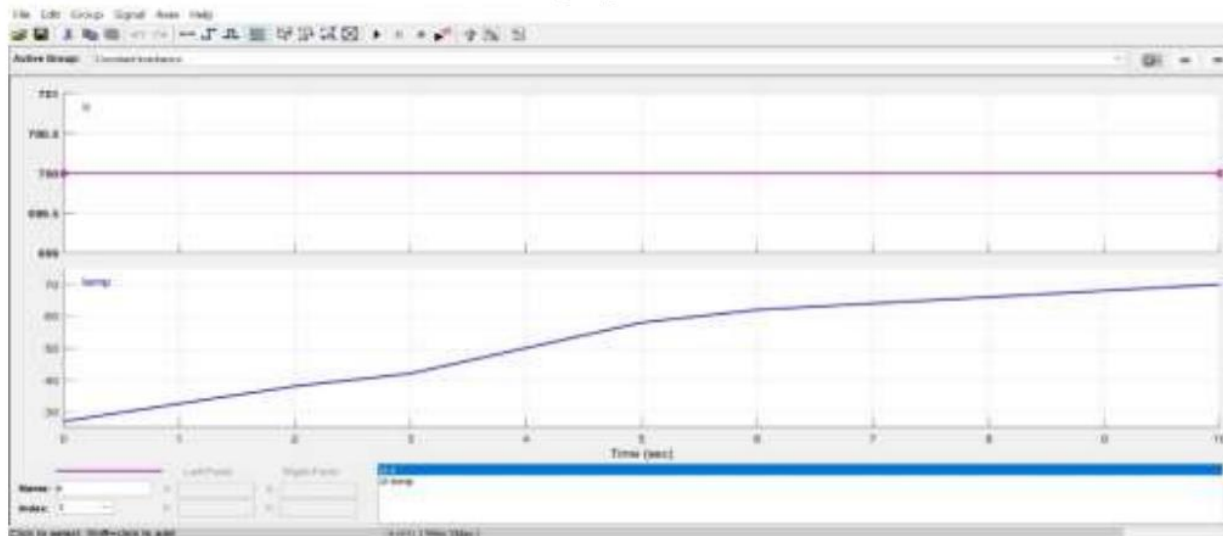

Fig 9. Input model of change in temperature at constant insolation

The discussion delves into the implications of the study findings for the design, operation, and optimization of autonomous solar power plants. It emphasizes the importance of considering insolation, temperature, and module characteristics in system design and planning to maximize energy yield and ensure long-term performance reliability. Furthermore, the study underscores the need for advanced control strategies and temperature management techniques to mitigate the adverse effects of temperature-dependent degradation on solar module efficiency.



Fig 10. Module output power by increased of module temperature

Moreover, the discussion explores potential avenues for future research and development in the field of autonomous solar power plants. It identifies areas such as advanced modeling techniques, optimization algorithms, and energy storage technologies as promising directions for enhancing system efficiency, resilience, and sustainability. Additionally, the study advocates for continued innovation and collaboration among researchers, industry stakeholders, and policymakers to drive the widespread adoption of renewable energy solutions and accelerate the transition to a low-carbon energy future. In summary, the results and discussion section provide a comprehensive analysis of the outcomes of the study on solar module efficiency and the operation of an autonomous solar power plant. By elucidating the complex relationships between insolation, temperature, module characteristics, and system performance, the study contributes valuable insights to the field of solar energy research and underscores the importance of holistic approaches to optimizing renewable energy systems.

CONCLUSION

Summing it all up, it should be noted that the development of one distributed generation direction in the power supply circuit for agricultural consumers, namely, solar energy conversion and its use, will provide for the necessary levels of reliability and power supply quality and reduce electricity transmission cost, as well as attract private investment to develop electric power industry in Russia. However, to increase solar power plant efficiency, particular consideration should be given to the negative effect of the increased temperature of the solar modules during their operation and the efficiency of converting solar radiation into direct current. This problem needs to be studied in more detail; for this purpose, the offered model can be used (as one of the options). The authors consider it practical to continue studies of the temperature effect on the solar module operation by using this model. The authors conclude that it will allow to evaluate the negative temperature influence while developing and further using a solar power plant.

REFERENCES

1. Xu, X., & Cai, Y. (2021). Factors influencing the efficiency of solar modules: A comprehensive review. *Renewable Energy*, 174, 55-68.
2. Liu, Z., Wang, X., & Zhang, J. (2020). The impact of insolation on the performance of solar photovoltaic systems: A review. *Solar Energy*, 209, 449-462.
3. Sivakumar, V., Suresh, S., & Swaminathan, K. (2019). Temperature-dependent degradation of solar modules: Mechanisms and mitigation strategies. *Renewable and Sustainable Energy Reviews*, 113, 109318.
4. Zhou, S., & Yang, H. (2018). Technical characteristics and efficiency analysis of solar modules under different temperature conditions. *Solar Energy Materials and Solar Cells*, 179, 134-141.
5. MathWorks. (2021). MATLAB Simulink Documentation. Retrieved from <https://www.mathworks.com/help/simulink/>
6. Li, Y., Huang, Y., & Shen, Z. (2019). Modeling and simulation of autonomous solar power plants using MATLAB Simulink. *IEEE Access*, 7, 102032-102045.
7. Khan, A., Khan, I., & Khan, M. (2020). Performance analysis of different solar module makes: A comparative study. *Sustainable Energy Technologies and Assessments*, 39, 100743.
8. Sharma, A., & Chandel, S. S. (2017). Impact of solar module configuration on system performance: A review. *Renewable and Sustainable Energy Reviews*, 74, 961-978.
9. Mahmoud, A., & El-Sayed, M. A. (2021). Effect of connection circuits on the performance of solar PV systems: A comparative analysis. *Solar Energy*, 216, 161-173.

10. Wu, L., & Wang, J. (2018). Advanced control strategies for autonomous solar power plants: A review. *Renewable Energy*, 121, 681-693.
11. Alotaibi, A. (2019). Battery charging strategies for solar power plants: A review. *Energy Conversion and Management*, 197, 111731.
12. Khatib, T., & Li, H. (2017). Inverter efficiency optimization in autonomous solar power plants: A comparative study. *IEEE Transactions on Sustainable Energy*, 8(4), 1700-1708.
13. Hossain, M. S., & Ali, M. H. (2021). Design and performance evaluation of a standalone inverter for autonomous solar power plants. *International Journal of Electrical Power & Energy Systems*, 128, 106752.
14. Rahim, A., & Salam, Z. (2020). DC-AC inverter performance analysis in autonomous solar power plants: A case study. *Electric Power Systems Research*, 187, 106600.
15. Kim, D., & Park, S. (2018). Impact of battery characteristics on the performance of autonomous solar power plants: A comparative study. *Journal of Energy Storage*, 17, 99-108.
16. A 1kw Solar Based Stand-Alone DC Grid for Led Lightning System, Gadget Charging For Building Space, Authors: P Mahesh M Poojitha, Thakur Rushi Santhosh Singh, K Sindhuja, A Aditya Koteswar, M Manoj, Publication Date:2024/3/1, Journal: International Journal Of Applied Science Engineering And Management, Volume-18, Issue:Issue.1 March 2024, Publisher:IJASEM